

See discussions, stats, and author profiles for this publication at: <https://www.researchgate.net/publication/220865721>

# SewerSnort: A Drifting Sensor for In-situ Sewer Gas Monitoring

Conference Paper · June 2009

DOI: 10.1109/SAHCN.2009.5168971 · Source: DBLP

---

CITATIONS

48

---

READS

299

8 authors, including:



**Jonathan Friedman**

Assembly, Inc.

42 PUBLICATIONS 1,406 CITATIONS

SEE PROFILE



**Uichin Lee**

Korea Advanced Institute of Science and Technology

250 PUBLICATIONS 9,664 CITATIONS

SEE PROFILE



**Luiz Vieira**

Federal University of Minas Gerais

153 PUBLICATIONS 4,594 CITATIONS

SEE PROFILE

# SewerSnort: A Drifting Sensor for In-situ Sewer Gas Monitoring

Jihyoung Kim, Jung Soo Lim, Jonathan Friedman<sup>†</sup>, Uichin Lee

Luiz Vieira, Diego Rosso<sup>‡</sup>, Mario Gerla, Mani B. Srivastava<sup>†</sup>

UCLA CS, UCLA EE<sup>†</sup>, UCI CEE<sup>‡</sup>

{jhkim,jlim,ucllee,luiz,gerla}@cs.ucla.edu, {jf,mbs}@ee.ucla.edu<sup>†</sup>, bidui@uci.edu<sup>‡</sup>

**Abstract**—Biochemical activities in sewer pipes generate various volatile substances that lead to several serious problems such as malodor complaints and lawsuits, concrete and metal corrosion, increased operational costs, and health risks. Frequent inspections are critical to maintain sewer health, yet are extremely expensive given the extent of the sewer system and the “unfriendliness” of the environment. In this paper we propose SewerSnort, a low cost, unmanned, fully automated in-sewer gas monitoring system. A sensor float is introduced at the upstream station and drifts to the end pumping station, collecting location tagged gas measurements. The retrieved SewerSnort provides an accurate gas exposure profile to be used for preventive maintenance and/or repair. The key innovations of SewerSnort are the fully automated, end-to-end monitoring solution and the low energy self localizing strategy. From the implementation standpoint, the key enablers are the float mechanical design that fits the sewer constraints and the embedded sensor design that matches the float form factor and complies with the tight energy constraints. Experiments based on a dry land emulator demonstrate the feasibility of the SewerSnort concept, in particular, the localization technique and the embedded sensor design.

## I. INTRODUCTION

A Wastewater Collection System (WCS) conveys sewage to treatment or disposal facilities using a system of sewer pipes. Sewer system inspection and maintenance must be done proactively and with diligence because sewer pipes are prone to damage from aging, excessive traffic, and biochemical reactions [5]. Exposed sewage from a leak or overflow will cause serious environmental and public health problems through groundwater contamination and infection [4].

Organic matter transported by the sewer results in sedimentation coating the walls and collecting along the bottom of the sewer pipe. Due to insufficient electron accepting ions (anaerobic conditions), the biochemical reactions taking place in the sediment and biofilm generate hydrogen sulfide ( $H_2S$ ), methane ( $CH_4$ ), and numerous other volatile substances (collectively, in-sewer gases) [11]. Hydrogen sulfide, a toxic and odorous gas, is a precursor to the formation of sulfuric acid ( $H_2SO_4$ ) which is destructive to metal and concrete – as well as humans [39]. Methane is highly flammable and may form explosive mixtures with air. It is also an asphyxiant and may displace oxygen in an enclosed space [30]. There is growing consensus that sewage systems contribute a non-negligible fraction of greenhouse gases (GHG) such as carbon dioxide ( $CO_2$ ) and methane [26], [9].

Direct sewer maintenance operations are life-threatening,

as a result, numerous lengthy and costly indirect approaches have evolved: *Pipe damage detection* is accomplished via the injection of smoke and fluorescent dyes [34], [25] or via remote inspection with cameras and sonar systems attached to tethered probes [34] or mobile robots [1]. *Flow monitoring* is achieved with the installation of meters at strategic locations such that the drainage system can be properly controlled to prevent overflows [35]. Finally, once a flow problem has been detected and localized flushing or chemical treatments are used to attain *sediment control* [4].

While pipe damage detection and flow monitoring have been actively studied in both industry and academia, in-sewer gas monitoring has received little attention due to the difficulty of in-situ measurements and the relative lack of sensor installations – mostly in treatment plants. To fill the gap the United States Environmental Protection Agency (EPA) recommends analytical modeling to predict sediment and gas concentration [4]. Yet, it is extremely difficult to model and fit a sewer system due to the large spatio-temporal variability. Accordingly, it seems that municipalities perform sewer flushing only when they receive odor complaints or lawsuits [2].

But there is strong rationale for in-sewer gas monitoring. It is a key indicator of sewer conditions (sediment build up, corrosion, and odor) [11] and can suggest areas for targeted supplemental study or corrective action. The collected data can be used to reduce the occupational health and safety risks of working in sewers which has recently become more common due to in-sewer fiber optic cable installations [40] and to help researchers better understand in-sewer gas phases and estimate the amount of GHG production in sewers [26], [9].

In this paper, we aim to design a low cost in-sewer gas monitoring system. Such a system would allow frequent inspection, early detection of problems, and targeted flushing measures – substantially improving service uptime, reducing the maintenance budget, enhancing illegal toxic dumping enforcement and improving public health through mitigating the contamination and infection risks. To this end, we propose SewerSnort, a novel method involving drifting sensors that monitor in-sewer gases. A SewerSnort node is dispensed upstream of the WCS. It measures in-sewer gas concentrations while floating downstream and marks these readings with their geographic location obtained from a set of beacons located beneath the sewer’s surface-accessible servicing portals (so called,

manholes). It is finally extracted at a wastewater treatment plant, pumping station, or sewer manhole using a screening device. The data is collected through traditional public network infrastructure systems such as municipal Wi-Fi, emerging low-power high-availability mesh networking systems such as [32], or, failing that, through short-range wireless download upon retrieval (physical contact with the probe once deployed in the sewer is not advisable due to surface contamination and biohazard).

In this paper, we make the following contributions to the field:

- We show the feasibility of a mobile drifting sensor by analyzing the sewer flow statistics and present the potential applications of in-sewer gas monitoring.
- We design an “inner-tube” shaped hull to handle the lateral force that pushes the drifter to the side of the sewers (known as the bank suction effect).
- We present the first single-supply differential ratiometric data acquisition architecture that targets electrochemical sensors for WCS monitoring applications. The design is implemented and evaluated. Controlled experiments confirm the accuracy of our gas sensor module.
- We propose a Received Signal Strength Indicator (RSSI) based localization scheme, which functions accurately in the underground GPS-denied sewer environment. Over-ground experiments based on a programmable mobile robot emulator confirm viability.

## II. BACKGROUND

### A. Wastewater Collection System

A WCS is the set of sewer pipes that collect human-waste contaminated water (sewage) and carry it to treatment or disposal facilities. It can be categorized as a separate sewer system or a combined sewer system depending on whether sanitary wastewater is separated from stormwater. The separate sewer system is essentially two wastewater drainage systems in parallel – a sanitary sewer discharging wastewater to a wastewater treatment plant and a storm sewer discharging storm water to a receiving water.<sup>1</sup> A combined sewer system drains both sanitary and stormwater to a wastewater treatment plant. Hydraulic characteristics also play a role. Gravity sewers transport wastewater by gravity and can only be constructed in compatible terrain. Failing that, a pressure sewer, which transports wastewater through supplemental artificial pressure from a pump station, must be employed.

A typical separate sanitary collection system (Figure 1) is organized as follows:

- *Lateral sewers* (also called branch or collecting sewers) are used to collect wastewater from buildings (entry points) and convey it to the main sewer. They are usually located underneath streets or utility easements.
- *Main sewers* are used to convey wastewater from lateral sewers to larger sewers (trunk or intercepting sewers).

<sup>1</sup>A receiving water denotes a stream or river that has water flowing in it, or a lake, pond, dugout, or slough that has water standing in it.

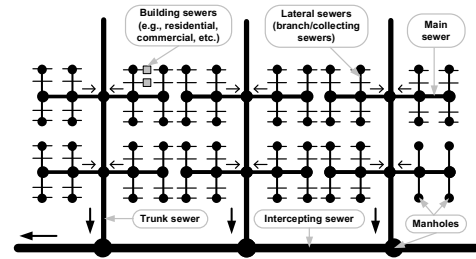

Fig. 1. Illustration of a sewer system

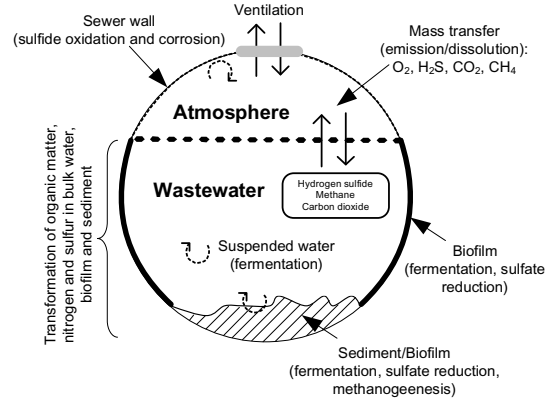

Fig. 2. Illustration of in-sewer processes

- *Trunk sewers* are large sewers that are used to convey wastewater from main sewers to the treatment or disposal facilities or to large intercepting sewers.
- *Intercepting sewers* are large sewers that are used to intercept a number of main and trunk sewers and convey wastewater to the treatment or disposal facilities.
- *Manholes* are used for sewer cleaning and inspection. They are located where the pipe system changes direction, grade, or diameter, at junctions, and, for small diameter sewers ( $d < 1.2m$ ) at intervals no greater than 120m.

### B. In-sewer processes

In-sewer processes that occur during conveyance of wastewater are physical, chemical and biological in nature. Physical processes are related to the build-up and erosion of sewer sediment. Chemical and physico-chemical processes occur due to the gas transfer over the air-water interface (e.g., emission of hydrogen sulfide) and the chemical oxidation and precipitation of sulfide. In biological processes, bacteria degrade organic compounds, such as formaldehyde ( $CH_2O$ ), to obtain carbon (for cellular growth and reproduction) and energy (for cellular activity). These transformations alter the biodegradability of the wastewater.

As shown in Figure 2, in-sewer biological processes happen in five phases [11]: suspended water, biofilm (slime layer), sediment, atmosphere, and the sewer wall. These phases interact and exchange relevant substances across the phase boundaries. An in-sewer bio-process will have different behavior based on microbial redox conditions: aerobic respiration when dissolved oxygen is present, anoxic respiration when nitrate/nitrite ions are present and anaerobic respiration when none of these (oxy-

Redox conditions	Possible Sewer Types	Sewer Gases
Aerobic (+oxygen)	Partly filled gravity sewer Aerated pressure sewer	Carbon dioxide ( $CO_2$ )
Anoxic (-oxygen,-nitrate)	Pressure sewer with nitrate	Carbon dioxide ( $CO_2$ )
Anaerobic (-oxygen,-nitrate,+sulfate)	Pressure sewer Full-flowing gravity sewer Gravity sewer (low slope, sediment)	Hydrogen sulfide ( $H_2S$ ) [ <i>sulfate reduction</i> ] Carbon dioxide ( $CO_2$ ) [ <i>fermentation</i> ] Methane ( $CH_4$ ) [ <i>methanogenesis</i> ]

TABLE I  
SEWER GASES UNDER DIFFERENT REDOX CONDITIONS

gen, nitrate/nitrite ions) are present.<sup>2</sup> In Table I, we summarize different redox conditions and relevant sewer gases generated in various types of sewers. Aerobic/anoxic respiration produces carbon dioxide, whereas anaerobic respiration generates numerous volatile substances that vaporize or evaporate at atmospheric pressure such as hydrogen sulfide (product of sulfate reduction), carbon dioxide (product of fermentation), and methane (product of methanogenesis).

In particular, hydrogen sulfide diffused into a thin liquid film on the sewer surface (see Figure 2) can be oxidized to sulfuric acid ( $H_2SO_4$ ) by microbial reactions [11]. Sulfuric acid may react with the alkaline cement ( $CaSO_4$ ) in the concrete pipes causing corrosion.

Each of these in-sewer processes can be analytically modeled using differential equations [36], [41]. The models typically consider various factors that influence reactions [36]. For instance, a sulfate reduction model takes the following factors as input: quantity of sulfate, Chemical Oxygen Demand (COD), temperature, pH, area-to-volume ratio (i.e., biofilm and sediment), flow velocity, anaerobic residence time [41].<sup>3</sup> In practice, however, accurately fitting a model to in-sewer processes is greatly challenging, for the present approaches make in-situ measurement extremely laborious and substantial data collection must be performed to count and to understand the spatio-temporal variability of the underlying model parameters while biological processes are correlated [36]. Understanding the overall sewer reactions in sewers is a challenging area of active interest in the urban water research community. Note that the goal of this paper is not to accurately estimate the model parameters of in-sewer processes, but to directly observe the behavior of various gas phases and to predict their potential impact on sewer maintenance and GHG emission given the sewer structure.

### III. SEWERSNORT SYSTEM OVERVIEW

#### A. System design requirements

Our main goal is to design an in-sewer gas monitoring system that considers the following requirements:

- *The system should be independent of pipe profile* (material, shape, size). The most widely used image capture

<sup>2</sup>A microbial “respiration” process consists of two steps (called redox process): *oxidation* of organic matter and *reduction* of an electron acceptor. In other words, bacteria break down organic matter and transfer electrons from the electron donor (organic matter) to the relevant electron acceptor (e.g., oxygen, nitrate/nitrite ions, sulfate ions)

<sup>3</sup>Chemical Oxygen Demand (COD) is defined as the quantity of a specified oxidant that reacts with a sample under controlled conditions.

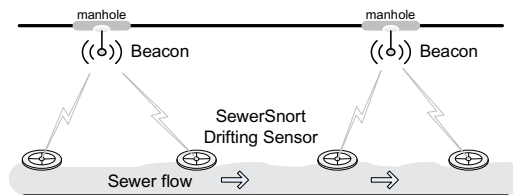

Fig. 3. SewerSnort monitoring scenario

technologies such as Closed-Circuit Television (CCTV), Sewer Scanner and Evaluation Technology (SSET), and sonar only work with a subset of the pipe materials and shapes deployed in WCSs [34].

- *The system should be scalable.* A large metropolitan city like Los Angeles has a WCS composed of over 12,000 km of pipelines [17].
- *The system should be able to access the entire extent of the WCS.* All current physical assessment methods are limited to a comparatively small travel distance from their access point into the WCS.
- *The system should be fielded with reasonable cost* such that the deployment, maintenance, and operational expenses allow for near continual redeployment. At present, CCTV inspection costs \$2.26/foot and SSET inspection costs \$3.47/foot. For the city of Los Angeles it could cost upwards of \$12.7 million USD to perform a single comprehensive inspection. A reduction of at least two orders of magnitude for an entire year of deployments is desired [23].

#### B. SewerSnort: Gas monitoring using drifting sensors

We propose SewerSnort, the use of drifting sensors to monitor in-sewer gases. Given that small sewers are typically under the aerobic redox condition and thus will not generate gases of interest (hydrogen sulfide and methane), SewerSnort provides inspection coverage only to the main, trunk, and intercepting sewers of the WCS. SewerSnort dispensers are deployed at strategic locations by analyzing the sewer map and inspection demands. They are typically located at an entry point to the sewer. The dispensing schedule can be configured based on the application scenario. For instance, if the operators want to understand how in-sewer gas level changes over time, they can float drifters at regular intervals for continual sampling.

Once a drifter is deployed, we need to track its position. Because the Global Positioning System (GPS) transmits from very high altitudes using only 50W transmitters and

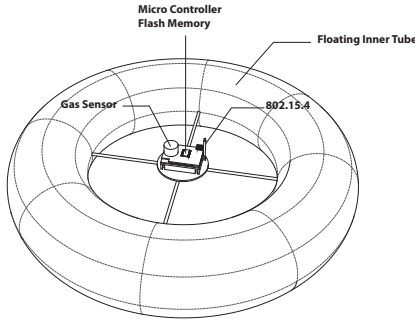

Fig. 4. SewerSnort drifter design

microwave-frequency carriers, the GPS signal does not readily penetrate the ground. We propose integrating a wireless beacon into the underside of every manhole cover in the region of interest. These beacons are preprogrammed with their positions allowing a drifter to localize itself by listening to the identity of nearby beacons (which implies their location) and the strength of their respective signals.

The main advantage of sewer drifters is their immunity to pipe profile. It is neither sensitive to the materials nor dependent on the shape of a sewer pipe. Yet, they compare favorably in other metrics as well. Conventional robotic systems are bulky, heavy, and require sufficient flow rate, external power, or internal power generation [19]. SewerSnort drifters are small, light, and battery-operated (e.g.,  $< 30\text{cm}$  in diameter, and  $< 0.5\text{kg}$  in weight) and can operate during low flow rate conditions.

### C. Feasibility of drifting sensors in sewers

The fluid flow in a pipe is classified as either laminar (a stable and streamlined flow) or turbulent (a highly irregular and random motion). To determine the type of flow we use its Reynolds number, i.e.,  $Re = \rho v \delta / \gamma$  where  $\rho$  is the fluid density,  $v$  is the fluid velocity,  $\delta$  is geometrical length associated with flow, and  $\gamma$  is the viscosity that characterize the degree of internal frictions in the fluid.

We consider the sewer flow to be laminar based on the following facts. First, sewers contain a high concentration of suspended solids which create great internal frictions and decrease the flow velocity. The concentration of suspended solids in a sewer has not been systematically measured. However, approximately 100 milligram per liter (mg/l) of suspended solids exists in the effluent after the primary treatment in the wastewater treatment plant, while the tap water contains less than 1 mg/l [37]. Second, the gravity slope of most pipelines is rather mild to control the flow velocity, thus preventing sewer rosin. For instance, the sewer design manual of Bureau of Engineering at Los Angeles specifies 0.003 radian (or  $0.1719^\circ$ ) for the pipe slope [29]. Third, concrete, which creates relatively more internal friction than copper, plastic or iron, is the most widely used material for sewer pipelines [4]. According to the Nikuradse's definition of mean height of roughness; copper and glass are 0.003, iron is 0.15, plastic is 0.03, and concrete is 6.0 where the higher number is the more rough is. Thus, the sewer flow can be classified

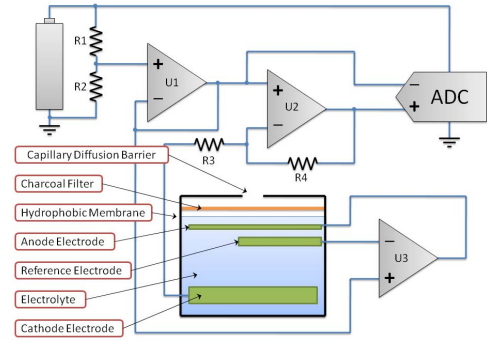

Fig. 5. A simplified schematic of the electrochemical gas sensor and analog signal conditioning elements. This differential ratiometric approach consumes  $< 15\mu\text{W}$  in our current implementation. Electromagnetic compatibility elements are not shown for clarity.

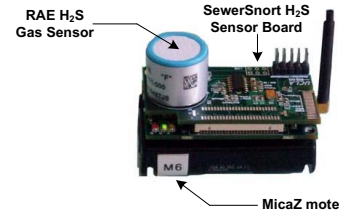

Fig. 6. The SewerSnort gas sensor board with a MicaZ mote

as laminar; in other words, it is steady and stable enough not to significantly affect in-situ gas measurement.

## IV. SEWERSNORT SYSTEM DESIGN

### A. Hull design

When a surface vessel moves through a constricted waterway, the current velocity gradient pushes the craft toward the nearest bank ultimately resulting in a collision. Our drifter will suffer from this phenomenon, known as the “bank suction” effect [6]. As our drifter approaches the sewer wall the water channel size reduces and in turn increases the velocity of the water on that side. The asymmetric flow around the drifter causes pressure differences. As a result, a lateral force will push the drifter to the side of the pipeline. The drifter will keep bouncing against the wall as it lacks any on-board motion control. We propose an inner tube hull that can roll along the pipeline sidewall (Figure 4). The sensing unit is placed in the middle of the inner tube to prevent wastewater from submerging it and the hull is tall enough to sustain the sensor above waterline in the event high turbulence capsizes the drifter.

### B. Gas sensing unit

1) *Electrochemical Gas Detection*: Electrochemical sensors detect a particular Gas Of Interest (GOI) by reacting with it and producing an electrical current proportional to the gas concentration. This current is developed between the sensor's anode and cathode electrodes (Figure 5) as one is oxidized and the other reduced. The exact chemistry is specific to the construction of the sensor and the GOI. In the following, we focus on hydrogen sulfide ( $\text{H}_2\text{S}$ ) gas sensing, as it is one of the key sewer indicators.

Our SewerSnort drifters are equipped with an RAE 032-0102-000 electrochemical sensor element [24] and a custom Analog Front End (AFE) that provides bias and signal conditioning functions. The oxidation reaction that takes place at the anode is:

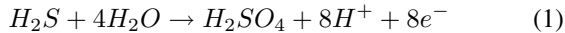

Note that the inputs include water. It is provided inside the sensor as an electrolyte into which the electrodes are immersed and sealed in by a gas-permeable hydrophobic membrane (Figure 5). Besides sealing in the electrolyte (water is repelled from the membrane – hydrophobia) and offering mechanical protection to the sensor, the membrane performs the additional function of filtering out unwanted particulates. A scrubber filter of activated charcoal is installed in front of the membrane to further enhance the sensor’s selectivity (the sensor’s preference for the GOI over other look-alike gasses).

These internal design choices reflect a fundamental tradeoff between the selectivity (ability to target just the GOI – allow fewer molecules in) and the sensitivity (encourage as much reaction as possible – allow more molecules in) of the sensor. Given that the detection reactions are basic public chemistry, the design of the capillary, choice of the filter material, and the shape of the electrodes are the most important differentiating elements among commercial vendors and, correspondingly, these are the design aspects most heavily patented. Careful attention should be paid to application requirements when selecting a vendor. With SewerSnort we chose an element with very high selectivity and moderate sensitivity.

2) *Power Concerns*: It is important to have a stable and constant Voltage at the anode electrode (w.r.t. the cathode), because, unaided, the Voltage will fluctuate as the reaction taking place on its surface is continuously introducing mobile charges. These fluctuations void the calibration curve as the Voltage changes in the electrolyte correspond to energy storage instead of a conversion to an electrical current which may be sensed. However, the SewerSnort drifters are battery-powered and must remain small, light, and inexpensive – precluding the use of large battery packs. Although, the use of modern Switch-Mode Power Supplies (SMPS) can achieve near 90% efficiencies, a SMPS must operate continuously to maintain the regulated output Voltage conditioning the electrodes. Given that the SewerSnort drifter must travel an enormous distance (compared to its own dimensions) and do so at slow speeds (due to low flow rate), it will take measurements at a very low sample rate. During the inter-sample interval, the sensor electronics will be idle, and minimizing power consumed in this “sleep” state is substantially more important than minimizing active sampling power. This presents the drifter design with a difficult tradeoff: Regulate the sensor power supply to stabilize the operating conditions and hence ensure the accuracy of the sensor’s calibration, but risk battery exhaustion, or allow the Voltage to drift, empower data collection over the entire trip, but compromise the sensor calibration and, therefore, collect potentially meaningless data.

3) *Ratiometric Signal Conditioning*: In this work we explore an alternative that proffers to circumvent the conflict between calibration accuracy and power consumption and in the process present the first single-supply differential ratiometric data acquisition architecture that targets electrochemical sensors for WCS monitoring applications. To maintain the sensor’s calibration curve the sensor must experience a nominal 0V bias condition ( $V_{anode} = V_{cathode}$  for  $I_{electrolyte} = 0$  and the amplifier must have sufficient dynamic-range (head room) to handle the increasing Voltage of the amplified output. To meet these two conditions without the use of a power supply, we connect the amplifiers directly to the battery in a single-sided configuration (no negative Voltage provided). An intermediate reference Voltage is generated that is an arithmetic ratio of the battery Voltage (in our implementation we used a ratio of  $\frac{1}{2}$ ). This ratiometric reference potential is routed to both the transconductance amplifier responsible for sinking current from the cathode and the feedback amplifier responsible for driving the anode. As both terminals of the sensor are biased by the same potential, absent charge injection from a reaction (no GOI present), the 0V condition is achieved. As the battery Voltage decreases over its cycle life, the reference Voltage decreases as well preserving the amplifiers head room.

### C. Localization

We build a radio-frequency (RF) based system to locate and to track a drifter. RF based localization has been widely used for indoor positioning via triangulation using measured signal strengths from multiple beacons [3], [18]. We can use either an empirically measured signal strength map [3], [18] or a theoretical model that captures signal attenuation over distance [3], [21]. Recent measurement studies by Howitt et al. proposed a radio wave propagation model for concrete storm drain pipes in 2.4 - 2.5GHz frequency band [12]. Using this model we estimate the location of the drifter inside the sewers. Unlike previous methods of “online” location tracking methods [3], [18], [21], we perform “off-line” signal processing on the measured signal strength samples to better estimate the trajectory of a drifter.

1) *RSSI-based SewerSnort localization*: To define a geospatial coordinate system an RF beacon is embedded beneath the manhole covers in the area of interest. The beacons broadcast their identity periodically, which corresponds to a specific physical location.<sup>4</sup> Aboard the drifter the beacon message is heard and decoded to determine the beacon’s identity while the average signal envelope power – the RSSI – is measured.

The relationship between RSSI and inter-radio distance may be approximated by the radio wave propagation model for concrete storm drain pipes [12]:

$$RSSI(d)_{rx} = P_{tx} - \alpha_{(a,\sigma)} \times d - A_{CL} \quad (2)$$

<sup>4</sup>Numerous techniques for low power medium access control exist and could be leveraged to reduce battery drain. These include supplemental “wake-up” RF circuitry [22] and low-power ultra-low drift clocking systems [28] to support extremely low duty-cycle time-division protocols [27]



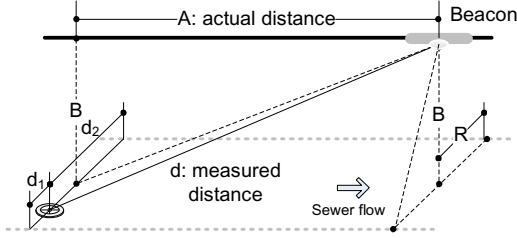

Fig. 7. Distance estimation in sewers

where  $RSSI(d)_{rx}$  is the received power at distance  $d$ ,  $P_{tx}$  is the transmitted power,  $\alpha_{(a,\sigma)}$  is the multimode attenuation loss ( $dB/m$ ) which is dependent on radius ( $a$ ) and conductivity ( $\sigma$ ) of a concrete pipe, and  $A_{CL}$  is the antenna coupling loss given in  $dB$ . The value of  $A_{CL}$  changes based on the position of the beacon inside the pipe [12]. Assuming the drifter is at the bottom of the pipe, the value of  $A_{CL}$  is smaller when the beacon is at the center of the pipe than at the top of the pipe. Hence, assuming that the position of the beacon is fixed at the top of the pipe, it is possible to calculate the depth of the water if we know the value of  $A_{CL}$  of the pipe. The value of  $A_{CL}$  and  $\alpha_{(a,\sigma)}$  are dependent on the radius ( $a$ ) and conductivity ( $\sigma$ ) of the concrete pipe and these values are empirically derived from multiple experiments [12].

We want to find the distance  $A$  for SewerSnort localization (see Figure 7). Knowing the radius of a pipe ( $R$ ), we need to find  $d_1, d_2$ , and flow level ( $B$ ) to calculate  $A$ . Also, as explained in section IV, bank suction may drift a SewerSnort to the wall of pipeline. Thus, we assume  $d_1 = 0$ ; i.e.,  $(d_2 - d_1)/2 = R/2$ . The current flow level ( $2R - B$ ) can be estimated, when the drifter passes by the beacon, which can be detected by tracking the change of RSSI (i.e., maximum point); i.e.,  $B = \sqrt{d^2 - R^2}$ . The distance  $A$  can be estimated as:  $A = \sqrt{(d^2 - R^2) + B^2}$ .

2) *De-noising RSSI samples*: A de-noising process must be done beforehand to apply the channel model in a real world. Although destructive/constructive reflections have a small impact on measured RSSI values when there exists a dominant LOS [15], they cause rapid fluctuation. To de-noise the raw RSSI data we choose to use the Empirical Mode Decomposition (EMD) [10]. The EMD effectively filters out noise from the non-stationary time series signals such as RSSI data in SewerSnort.

Briefly, EMD is a data-driven signal processing technique. EMD decomposes signals into  $n$  empirical modes first and produces the residue which is the mean trend or constants. EMD algorithm is comprised of successive steps as follows:

- 1) Identify all local maxima and local minima.
- 2) Connect all local maxima using a cubic spline line as an upper envelope.
- 3) Repeat step 2) for all local minima as a lower envelope.
- 4) Compute the mean as  $m(t) = \frac{E_{max}(t) + E_{min}(t)}{2}$ .
- 5) Extract the local detail  $h_1$  as  $h(t)_1 = X(t) - m(t)$  where  $X(t)$  is a RSSI data at time  $t$ .
- 6) Repeat step 1–5 by treating the local detail  $h_i$  from

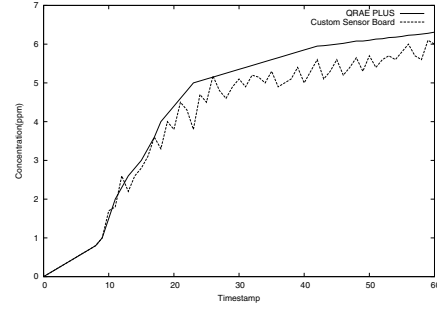

Fig. 8. Measured gas concentration using the QRAE industrial gas monitor and our SewerSnort AFE. The results agree almost exactly given that the sensor element uncertainty is  $\pm 0.5ppm$ .

the previous sifting as the raw data until  $h(t)_m = h(t)_{m-1} - m(t)_m$ . For example,  $h_1$ , the detail obtained after the first sifting, becomes data for the second sifting as  $h(t)_2 = h(t)_1 - m(t)_2$ .

- 7) Then, the intrinsic mode function component of the data becomes  $C(t) = h(t)_m$ .  $C(t)$  is a de-noised signal at time  $t$ .

## V. EXPERIMENTS

We validate the end-to-end capability of our custom  $H_2S$  sensor board by comparing it with that of QRAE PLUS Multi-Gas Monitor. QRAE is an off-the-shelf gas monitor that is equipped with the same type of RAE  $H_2S$  electrochemical sensor element. Mounting our sensor system atop an Amigobot, a commercial mobile robot, and using it to mimic the sewer's flow rate, we evaluate the overall system performance.

### A. SewerSnort gas sensor board evaluation

Industrial grade electrochemical sensor data acquisition modules cost in the thousands of dollars (far outside viability for SewerSnort). It is then incumbent to demonstrate that our low-power low-cost alternative (Figure 6) performs sufficiently well. Sensing fidelity is fundamentally limited by the electrochemical element itself. For our chosen element [24], the maximum sensitivity<sup>5</sup> to  $H_2S$  is  $0.75 \frac{\mu A}{ppm}$ , yet internal fluctuations and variations over temperature, limit accuracy to  $\pm \frac{1}{2}ppm$ . We chose a value of  $4.7\Omega$  for the transconductance element  $R_3$  (Figure 5) and a gain of 1000 ( $R_4 = R_3 \times gain$ ) as it minimizes offset and Johnson thermal noise, while still resolving  $0.5ppm H_2S$  changes into an output signal above the quantization threshold of the 10-bit ratiometric Analog-to-Digital Converter (ADC) in our chosen low-cost low-power processing node (a Crossbow MicaZ). The transfer function for a  $1ppm$  signal ( $0.75\mu A$ ) follows:

$$\frac{mV}{ppm} = 0.75 \frac{\mu A}{ppm} R_3 \frac{R_4}{R_3} \approx 3.5 \frac{mV}{ppm} \quad (3)$$

For evaluation, we placed the QRAE and SewerSnort monitors in an airtight container and introduced a  $10ppm H_2S$  gas

<sup>5</sup>In this context, Parts Per Million ( $ppm$ ) denotes the number of particles of a desired gas per one million particles of the background gas or gases

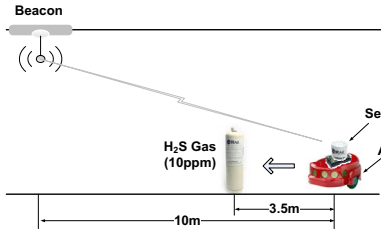

Fig. 9. Experiment scenario

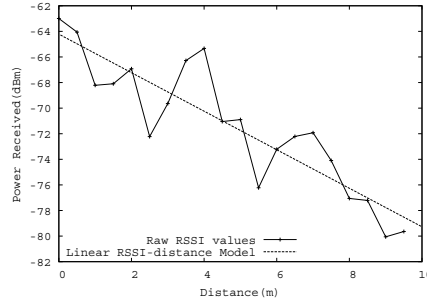

Fig. 10. Average received power results for 1.5m pipe

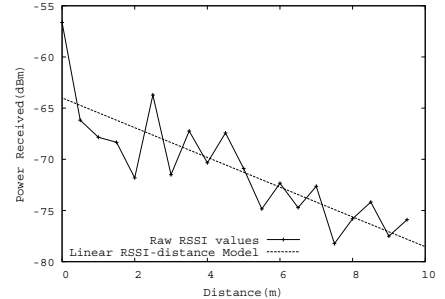

Fig. 11. Average received power results for 1.8m pipe

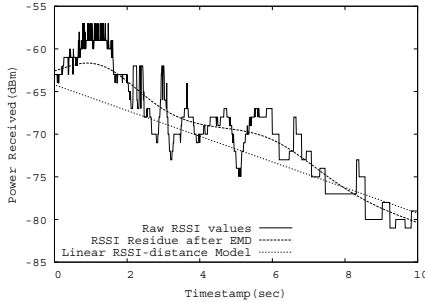

Fig. 12. Comparison with measured RSSI, EMD filtered RSSI, and Linear RSSI-distance Model in 1.5m pipe

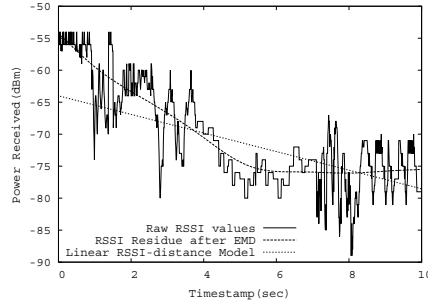

Fig. 13. Comparison with measured RSSI, EMD filtered RSSI, and Linear RSSI-distance Model in 1.8m pipe

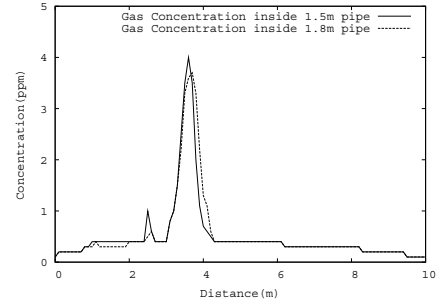

Fig. 14. Measured  $H_2S$  gas concentration (ppm)

via a sealed injection tube. Figure 8 presents the measured gas concentration in ppm. The figure shows that the measurement results from our AFE are within 0.5ppm of the QRAE on average – e.g. below the sensor element’s internal uncertainty.

### B. SewerSnort evaluation in a mobile environment

The SewerSnort gas board is interfaced with the MicaZ mote. Since the MicaZ mode has a 2.4 GHz IEEE 802.15.4 compatible radio, we also use it as a beacon node. We develop a TinyOS driver for the SewerSnort gas sensor board. The driver stores the following information in its flash memory: the gas measurements, the beacon messages that include the position of a beacon node, and the received signal strength of the beacon messages.

In the experiments, we first tried to derive the values of  $A_{CL}$  and  $\alpha_{(a,\sigma)}$  in Equation (2) for 10m concrete pipes with diameters of 1.5m and 1.8m. In order to estimate  $A_{CL}$  and  $\alpha_{(a,\sigma)}$  for each pipe, we used a robust linear algorithm in Matlab. We place a beacon at the end of the pipes, and measure the RSSI values from 0m to 10m, incrementing the measure point by 0.5m. Each measure collects 20 RSSIs, where every RSSI is averaged over a set of 500 samples. Thus, every measure requires 10000 samples. We configure the beacon to send out a beacon packet every 10ms, at the highest transmission power of the MicaZ. Figure 10 and Figure 11 show results of linear regression using Equation (2).

After obtaining  $A_{CL}$  and  $\alpha_{(a,\sigma)}$  for Equation (2), we consider the mobility scenario of the SewerSnort drifter. We mimic the mobility of a SewerSnort drifter by using an Amigobot robot, a programmable, wirelessly controllable mobile robot. The SewerSnort node is placed on top of the

Amigobot. We program the Amigobot to move from one end to the other with a constant speed of 1m/s in a straight line. A  $H_2S$  gas cylinder (10ppm) is placed 3.5m away from the starting point. The overall scenario is summarized in Figure 9. In our experiment, there is no effect of wind or ventilation.

Figure 14 shows that the measured gas concentration starts rapidly increasing around the 3.4m and then drastically decreasing after the 3.7m. This range includes the position where we place the gas cylinder. The reason why we observe lower concentration than 10ppm is due to gas diffusion in the air. A spike located at around 2.5m in 1.5m pipe is due to randomness of the gas diffusion.

For localization, we apply the EMD algorithm to denoise the RSSI measurement data in Figure 12 and Figure 13. We identify all local maxima  $X_{max}(t)$  as  $X(t-1) < X_{max}(t) > X(t+1)$  and all local minima  $X_{min}(t)$  as  $X(t-1) > X_{min}(t) < X(t+1)$  where  $X(t)$  is RSSI value at time  $t$ . We then use cubic Bezier curves and Bernstein polynomials to connect all local maxima and all local minima for the upper envelope and for the lower envelop respectively as follows:  $E(x) = \sum_{i=1}^n \binom{3}{i} X_i (1-t)^{3-i} t^i$ . After the 4th iteration of sifting, we reach the termination condition. Figure 12 and Figure 13 show the final residue after denoising.

For the purpose of geo-tagging, we assume that SewerSnort is drifting along the sewers at a constant speed. Note that Equation (2) can be used to estimate distance using measured RSSI data, but the resulting distance estimates over time fluctuate; for instance, a drift may flow against the flow direction. Instead, we search for the drifter speed that minimizes the errors between our linear model and the smoothed RSSI values. For each direction, we start from the peak RSSI value.



In Figure 12 and Figure 13, we plot measured RSSI values, EMD filtered RSSI values, and our linear model with speed  $v$  that minimizes errors. The results show that the estimated speed is very close to the experiment scenario (less than 5% error). This meter-level accuracy may be sufficient for most sewer gas monitoring scenarios. If an application requires more accuracy, we need additional devices such as an inertial navigation device and a probabilistic localization model, which is part of our future work.

## VI. RELATED WORK

Wireless sensor networks have been widely utilized in various environmental monitoring systems. Among the wealth of research contributions, this section reviews only the few that are most significantly related to SewerSnort.

### A. Advanced pipeline monitoring systems

Mobile robots can perform sewer inspection (e.g., anomaly detection) by autonomously navigating a pipeline. They are typically equipped with lights and cameras for pipeline profiling, and various sensors (e.g., sonar, infrared, laser) for autonomous navigation. To name a few prototypes, there are KURT developed by Kirchner et al. [14] and KANTARO by Ahrary et al. [1]. Mobile robot research in sewers has been focused on localization using an internal map and feature detection (e.g., manholes and inlets). Teichgräber et al. [33] proposed SEK, a “cable-guided” floating inspection tool that conducts camera inspections, recording major abnormalities such as erosion, deposits, obstacles and leaks in the gas space. SEK differs from SewerSnort in that (1) SewerSnort is an “unteathered” lightweight drifter that monitors in-sewer gases, and (2) SewerSnort performs localization using the beacons installed beneath sewer manholes.

Wireless sensor networks have recently employed in sewer monitoring [31], [13]. PipeNet [31] uses a network of fixed wireless sensors to detect and locate leaks in the “full flowing” water transmission pipeline. The system collects pressure, flow velocity, and acoustic/vibration data at the fixed points along the pipelines. Then, an analytic algorithm is applied to detect and to locate the leaks. The IDEAS laboratory in Purdue university used a wireless sensor network for developing a system to prevent Combined Sewer Overflow (CSO) in South Bend, IN [13]. The system transmits an alert alarm through a wireless channel to facilitate automatic flow diversion when the flow level reaches the threshold.

### B. Mobile robot localization in sewers

Mobile robot localization may be classified as relative, absolute, or a mixture of both. Relative localization uses internal sensors to estimate its current location such as odometry using internal sensors and dead reckoning using gyroscopes and compasses. As the robot moves, its actual position may deviate due to the accumulation of errors (e.g., wheel slippage). Thus, periodic absolute localization is crucial to long-term performance. Absolute localization requires either active beacons that transmit signals with position information (e.g.,

GPS), or known landmarks recognizable by the robot. The most popular approach is relative localization with landmark recognition. In sewers, there are only a few local features such as manholes, junctions, pipe joints and inlets that can be used as landmarks for localization [19]. Unfortunately, landmark detection in sewers experiences uncertainty with regard to detection and identity. Bayesian models are typically used to solve this problem using the conditional probability of the estimated location with respect to the observation and to the a priori probability distribution. Popular Bayesian methods include Kalman filtering [20], Markov [8], and Particle filtering (or Monte Carlo localization) [7]. A SewerSnort drifter localizes itself using active 802.15.4 beacons installed in sewer manholes. We are currently exploring augmenting the drifter with an inertial navigation sensor suite based on the works of [38]; and (2) the Hidden Markov model (used in speech reorganization) will be used to find the trajectory that minimizes the error [16].

## VII. CONCLUSION

This paper has presented an innovative sewer gas monitoring system based on a floating, drifting embedded sensor platform, the SewerSnort. Experiments based on a dry land robotic emulator have demonstrated the feasibility of the system, with extremely accurate gas readings aboard the float and adequate location estimates (errors within 5% over hundreds of meters). The results are encouraging and will stimulate further research in the field. Besides deploying an in-situ sewer experiment campaign, we plan to address new applications such as measuring flow levels, detecting leaks and monitoring exceptional (if not illegal) dumps. Preventive metal pipe maintenance will be assisted by the comparison of historical gas readings with typical pipe decay. Finally, attention will go to manhole beacons: localization accuracy will be investigated under different beacon placement strategies, localization may need to handle cases where a mobile node is not within the range of any of the beacons due to a large distance between manholes, and; manhole beacons will be equipped with storage to track the float, for remote progress monitoring and for float retrieval in case of mechanical failure.

## ACKNOWLEDGEMENT

We thank RAE Systems for providing a QRAE gas detector and  $H_2S$  electrochemical sensors (RAE 032-0102-000). We thank Woonghee Lee for providing 3D SewerSnort schematic. We appreciate the courtesy of Mr. Cowden, CEO of Rialto Concrete Pipe company, who provided us the experimental environment. This work is supported in part by the National Science Foundation under Grant No. 0722046.

## REFERENCES

- [1] A. Ahrary, L. Tian, S. ichiro Kamata, and M. Ishikawa. Navigation of an Autonomous Sewer Inspection Robot Based on Stereo Camera Images and Laser Scanner Data. *Int'l Journal on Artificial Intelligence Tools*, 16(5):611–625, Aug. 2008.
- [2] Cleveland Hopkins Airport Fumes Worry Workers, Remain Mystery. <http://archives.californiaaviation.org/airport/msg16476.html>.

- [3] P. Bahl and V. Padmanabhan. RADAR: An In-Building RF-based User Location and Tracking System. In *INFOCOM'00*, Tel-Aviv, Israel, Mar. 2000.
- [4] C.-Y. Fan, R. Field, and F. Hsiung Lai. Sewer-Sediment Control: Overview of an EPA Wet-Weather Flow Research Program. Technical Report EPA-600-J-03-188, US-EPA, National Risk Management Laboratory, Water Supply and Water Resource Division, Urban Watershed Management Branch, Edison, NJ, USA, 2006.
- [5] R. Fenner. Approaches to Sewer Maintenance: A Review. *Urban Water*, 2(42):343–356, Dec. 2000.
- [6] M. W. Fincham. Big Boats, Narrow Channels. *Chesapeake Quarterly Online*, 4(2), Dec. 2005.
- [7] D. Fox, W. Burgard, F. Dellaert, and S. Thrun. Monte Carlo Localization: Efficient Position Estimation for Mobile Robots. In *National Conference on Artificial Intelligence*, Orlando, FL, July 1999.
- [8] D. Fox, W. Burgard, and S. Thrun. Markov Localization for Mobile Robots in Dynamic Environments. *Journal of Artificial Intelligence Research*, 11:391–427, 2006.
- [9] A. Guisasaola, D. de Haas, J. Keller, and Z. Yuan. Methane Formation in Sewer Systems. *Water Research*, 42(6-7):1421–1430, Oct. 2008.
- [10] N. E. Huang, Z. Shen, S. R. Long, M. C. Wu, H. H. Shih, Q. Zheng, N.-C. Yen, C. C. Tung, and H. H. Liu. The Empirical Mode Decomposition and the Hilbert Spectrum for Nonlinear and Non-stationary Time Series Analysis. *Royal Society of London Proceedings Series A*, 454(1971):903, 1998.
- [11] T. Hvitved-Jacobsen. *Sewer Processes: Microbial and Chemical Process Engineering of Sewer Networks*. CRC, 2001.
- [12] S. K. I. Howitt, J. Khan. Lumped parameter radio wave propagation model for storm drain pipes. 2009.
- [13] Environmental monitoring at IDEAS). <https://engineering.purdue.edu/IDEAS/Enviro.html>.
- [14] F. Kirchner and J. Hertzberg. A Prototype Study of an Autonomous Robot Platform for Sewerage System Maintenance. *Autonomous Robots*, 4(4):319–331, Apr. 1997.
- [15] E. Kjeldsen and M. Hopkins. An Experimental Look at Rf Propagation in Narrow Tunnels. In *MILCOM'06*, Washington DC, Sep. 2006.
- [16] J. Krumm and E. Horvitz. LOCADIO: Inferring Motion and Location from Wi-Fi Signal Strengths. In *Mobiquitous'04*, Boston, MA, Aug. 2004.
- [17] Year at a Glance 2006–2007, City of Los Angeles, Department of Public Works, Bureau of Sanitation, 2007.
- [18] K. Lorincz and M. Welsh. MoteTrack: A Robust, Decentralized Approach to RF-Based Location Tracking. In *LoCA'05*, Munich, Germany, May 2005.
- [19] A. Nassiraei, Y. Kawamura, A. Ahrary, Y. Mikuriya, and K. Ishii. A New Approach to the Sewer Pipe Inspection: Fully Autonomous Mobile Robot “KANTARO”. In *IECON 2006*, Paris, Nov. 2006.
- [20] R. Negenborn. Robot Localization and Kalman Filters. Technical Report INF/SCR-0309, Utrecht University, 2003.
- [21] P. Pathirana, N. Bulusu, A. Savkin, and S. Jha. Node Localization Using Mobile Robots in Delay-Tolerant Sensor Networks. *IEEE Transactions on Mobile Computing*, 4(3), May/June 2005.
- [22] N. Pletcher and J. M. Rabaey. *Ultra-Low Power Wake-Up Receivers for Wireless Sensor Networks*. PhD thesis, EECS Department, University of California, Berkeley, May 2008.
- [23] Connection Code Bulletin 2008 – 4. [http://www.powerwater.com.au/\\_data/assets/pdf\\_file/0016/6235/bulletin\\_2008\\_4\\_CCTV\\_sewer\\_inspection\\_requirement.pdf](http://www.powerwater.com.au/_data/assets/pdf_file/0016/6235/bulletin_2008_4_CCTV_sewer_inspection_requirement.pdf).
- [24] Datasheet. Electrochemical  $H_2S$  Sensor 032-0102-000, RAE Systems.
- [25] D. M. Revitt, J. B. Ellis, and N. Paterakis. Comparison of Tracer Techniques for Monitoring Sewer Losses. *Journal of Environmental Monitoring*, 8(5):564–571, Apr. 2006.
- [26] D. Rosso and M. K. Stenstrom. The Carbon-sequestration Potential of Municipal Wastewater Treatment. *Chemosphere*, 70(8):1468–1475, Feb. 2008.
- [27] T. Schmid, J. Friedman, Z. M. Charbiwala, Y. H. Cho, and M. B. Srivastava. Low-Power High-Accuracy Timing Systems for Efficient Duty Cycling. In *ISLPED'08*, Bangalore, India, Aug. 2008.
- [28] T. Schmid, J. Friedman, Z. M. Charbiwala, Y. H. Cho, and M. B. Srivastava. XCXO: An Ultra-low Cost Ultra-high Accuracy Clock System for Wireless Sensor Networks in Harsh Remote Outdoor Environments. In *ISSCC/DAC'08*, San Francisco, CA, Feb. 2008.
- [29] Sewer Design Manual – Part F. <http://eng.lacity.org/techdocs/sewer-ma/index.htm>.
- [30] A. U. Spencer, S. S. Noland, and L. J. Gottlieb. Bathtub Fire: An Extraordinary Burn Injury. *Journal of Burn Care & Research*, 27(1):97–98, Jan./Feb. 2006.
- [31] I. Stoianov, L. Nachman, and S. Madden. PIPENET: A Wireless Sensor Network for Pipeline Monitoring. In *IPSN'07*, Cambridge, MA, Apr. 2007.
- [32] Streetline City Infrastructure Technologies. <http://www.streetlinenetworks.com/site/index.php>.
- [33] B. Teichgräber, J. Stemplewski, H. Althoff, and N. Elkmann. Remote Controlled Inspection Device for Large Sewers. *Water Practice & Technology*, 1(4), 2006.
- [34] US-EPA. Guide For Evaluating Capacity, Management, Operation, and Maintenance (CMOM) Programs At Sanitary Sewer Collection Systems. Technical Report EPA-305-B-05-002, US-EPA Office of Enforcement and Compliance Assurance, Jan. 2005.
- [35] US-EPA. Real Time Control of Urban Drainage Networks. Technical Report EPA-600-R-06-120, US-EPA Office of Research and Development, Sep. 2006.
- [36] J. Vollertsen, A. H. Nielsen, H. S. Jensen, and T. Hvitved-Jacobsen. Modeling the Formation and Fate of Odorous Substances in Collection Systems. *Water Environment Research*, 80(2):118–126, Feb. 2008.
- [37] Wellcare Information for You about Turbidity in Drinking Water. <http://www.watersystemscouncil.org>.
- [38] O. J. Woodmann. An Introduction to Inertial Navigation. Technical Report TR-696, UCAM-CL, 2007.
- [39] C. Yalamanchili and M. D. Smith. Acute Hydrogen Sulfide Toxicity due to Sewer Gas Exposure. *The American Journal of Emergency Medicine*, 26(4):518.e5–518.e7, Apr. 2006.
- [40] L. Zeindlhofer. Filling the Sewer Pipe – Advanced FTTH Deployment Technologies. In *FTTH Conference Expo'07*, Orlando, FL, Sep.-Oct. 2007.
- [41] L. Zhang, P. D. Schryver, B. D. Gusseme, W. D. Muynck, N. Boon, and W. Verstraete. Chemical and Biological Technologies for Hydrogen Sulfide Emission Control in Sewer Systems: A Review. *Water Research*, 42(1-2):1–12, Jan. 2008.